

MAHLE

Industry

Low Pressure Filter/Suction Filter

Pi 1941

Nominal pressure 10/25 bar (140/360 psi), up to nominal size 63

1. Features

High performance filters for modern hydraulic systems

- Provided for pipe installation
- Modular system
- Compact design
- Minimal pressure drop through optimal flow design
- Visual maintenance indicator
- Threaded connections
- Quality filters, easy to service
- Equipped with highly efficient glass fibre Sm-x and Mic filter elements
- Beta rated elements according to ISO 16889 multipass test
- Elements with high differential pressure stability and dirt holding capacity
- Worldwide distribution



2. Flow rate/pressure drop curve complete filter

■ 190 mm²/s
■ 33 mm²/s

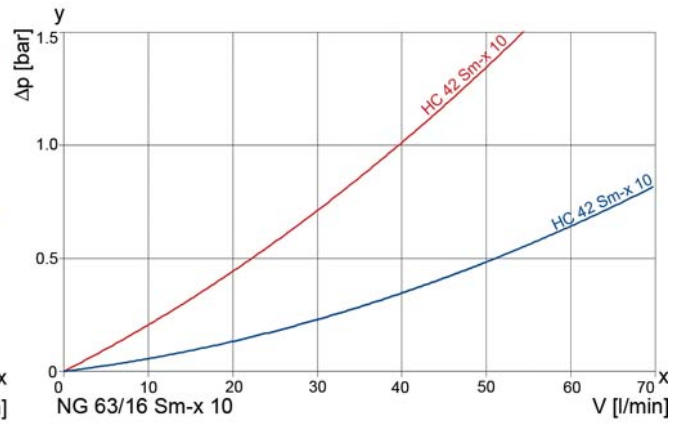
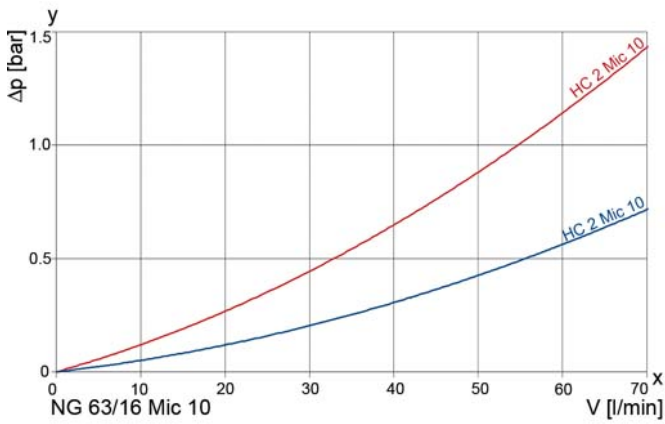
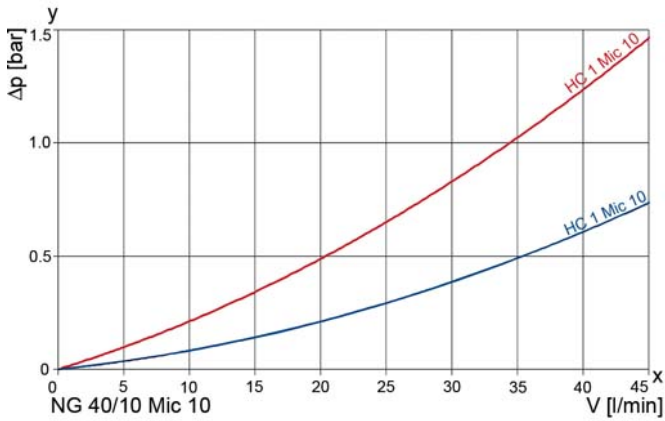
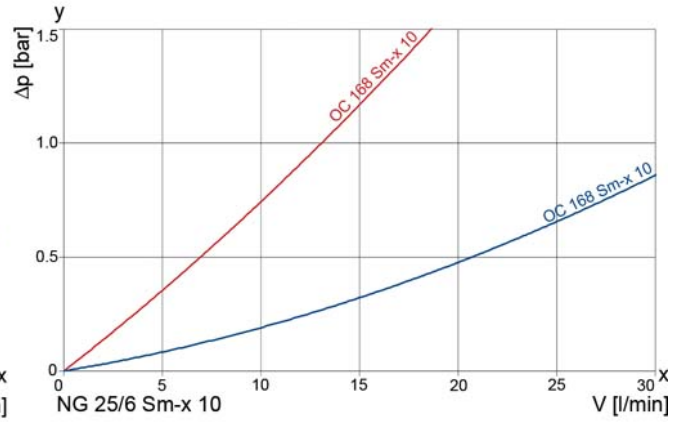
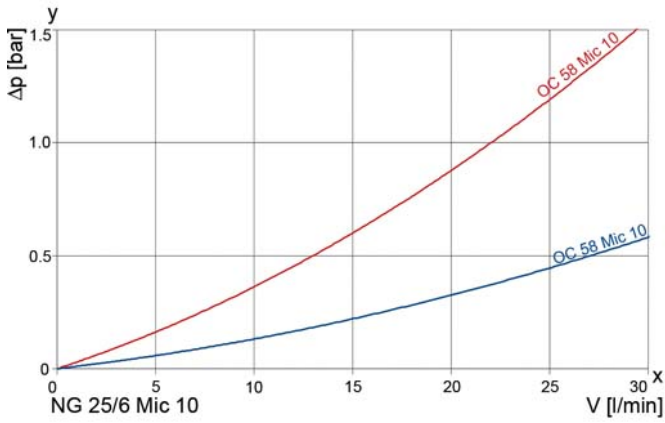
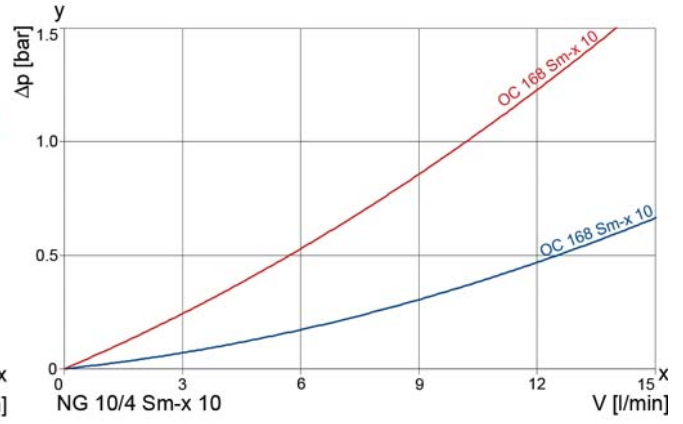
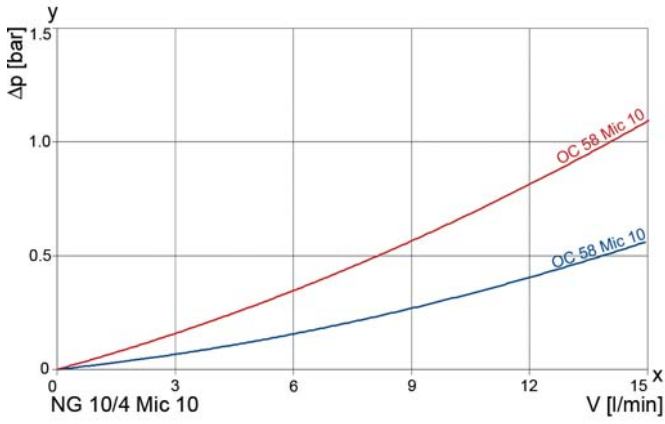

y = differential pressure Δp [bar]
 x = flow rate V [l/min]

3. Separation grade characteristics

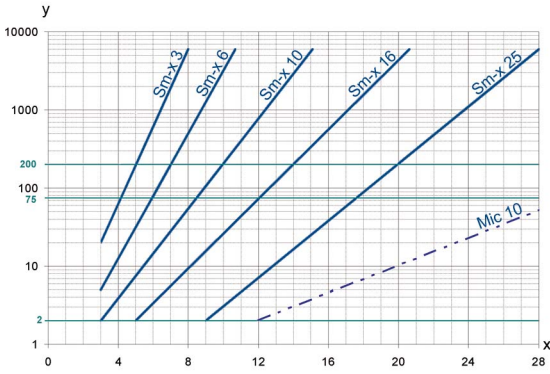

y = beta-value
x = particle size μm

determined by multipass tests (ISO 16889)
calibration according to ISO 11171 (NIST)

4. Filter performance data

tested according to ISO 16889 (multipass test)

Sm-x elements with
max. Δp 5 bar

Sm-x 10 $\beta_{10(C)} \geq 75$

values guaranteed up to
5 bar differential pressure

5. Quality assurance

MAHLE filters and filter elements are produced according to the following international standards:

| Norm | Designation |
|--------------|---|
| DIN ISO 2941 | Hydraulic filter elements: Verification of burst resistance |
| DIN ISO 2942 | Hydraulic filter elements: Determination of fabrication integrity |
| DIN ISO 2943 | Hydraulic filter elements: Verification of material compatibility with hydraulic fluids |
| DIN ISO 3723 | Hydraulic filter elements: Method for testing end-cap load |
| DIN ISO 3724 | Hydraulic filter elements: Verification of flow fatigue characteristics |
| ISO 3 968.2 | Hydraulic filter elements: Evaluation of pressure drop versus flow |
| ISO 16889 | Hydraulic filter elements: Testing of filter performance |

6. Symbols

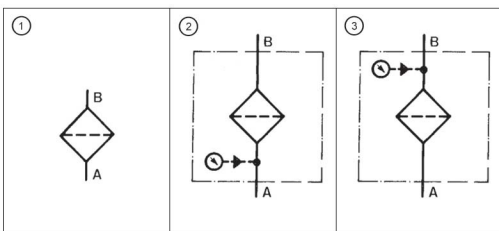

7. Order numbers

Example for ordering filters:

1. Housing design

V= 63 l/min, pressure gauge + spin-on cartridge Mic 10

Type Pi 1941/10/G¾/DM + HC 2

Order number 77807811 + 72013241

7.1 Housing design/order number for pressure-side installation

| Nominal flow rate NG [l/min] | Order number | Type | ① | ② |
|---------------------------------|--------------|--------------------|------------|---------------------|
| | | | no options | with pressure gauge |
| 10 | 77664360 | Pi 1941/10/G¾ | | |
| | 77812225 | Pi 1941/10/G¾/DM | | |
| 25 | 77664386 | Pi 1941/10/G3/8 | | |
| | 77815509 | Pi 1941/10/G3/8/DM | | |
| 40 | 77664394 | Pi 1941/10/G½ | | |
| | 77664402 | Pi 1941/10/G½/DM | | |
| 63 | 77664378 | Pi 1941/10/G¾ | | |
| | 77807811 | Pi 1941/10/G¾/DM | | |

7.2 Spin-on cartridges

| Nominal flow rate NG [l/min] press-/suct. side | Order number | Type | Filter material | max. Δ p [bar] | Filter surface [cm²] |
|---|--------------|--------|-----------------|----------------|----------------------|
| 10/4 | 77785983 | OC 58 | Mic 10 | 5 | 1775 |
| | 77500184 | OC 168 | Sm-x 10 | | 1309 |
| 25/6 | 77785983 | OC 58 | Mic 10 | 5 | 1775 |
| | 77500184 | OC 168 | Sm-x 10 | | 1309 |
| 40/10 | 77640899 | HC 1 | Mic 10 | 5 | 3000 |
| 63/16 | 72013241 | HC 2 | Mic 10 | 5 | 5440 |
| | 77501372 | HC 42 | Sm-x 10 | | 3360 |

7.3 Housing design/order numbers for suction-side installation

| Nominal flow rate NG [l/min] | Order number | Type | ① | ③ |
|---------------------------------|--------------|--------------------|------------|-------------------|
| | | | no options | with vacuum gauge |
| 4 | 77664360 | Pi 1941/10/G¾ | | |
| | 77894033 | Pi 1941/10/G¾/UM | | |
| 6 | 77664386 | Pi 1941/10/G3/8 | | |
| | 77894041 | Pi 1941/10/G3/8/UM | | |
| 10 | 77664394 | Pi 1941/10/G½ | | |
| | 77894058 | Pi 1941/10/G½/UM | | |
| 16 | 77664378 | Pi 1941/10/G¾ | | |
| | 77658966 | Pi 1941/10/G¾/UM | | |

8. Technical specifications

| | |
|--------------------------------------|--|
| Design: | line mounting filter |
| Nominal pressure*: | 10 bar (140 psi) |
| Test pressure: | 13 bar (180 psi) |
| Temperature range: | -10 °C to +120 °C (other temperature ranges on request) |
| Filter head material: | GDAL |
| Spin-on cartridge material: | St |
| Sealing material: | NBR |
| Installation position: | preferably vertical |
| Indicating range pressure manometer: | 0 to 10 bar |
| Indicating range vacuum gauge: | -1 to 0 bar |

*For the combination of the housing designs as per 7.1 with medium-pressure spin-on cartridges at 25 bar pressure refer to data sheet "spin-on cartridges" for dimensions and specifications.

We draw attention to the fact that all values indicated are average values and do not always occur in specific cases of application. Our products are continually being further developed. Values, dimensions and weights can change as a result of this. Our specialized department will be pleased to offer you advice.

We recommend you to contact us concerning applications of our filters in areas governed by the EU Directive 94/9 EC (ATEX 95). The standard version can be used for liquids based on mineral oil (corresponding to the fluids in Group 2 of Directive 97/23 EC Article 9). If you consider to use other fluids please contact us for additional support.

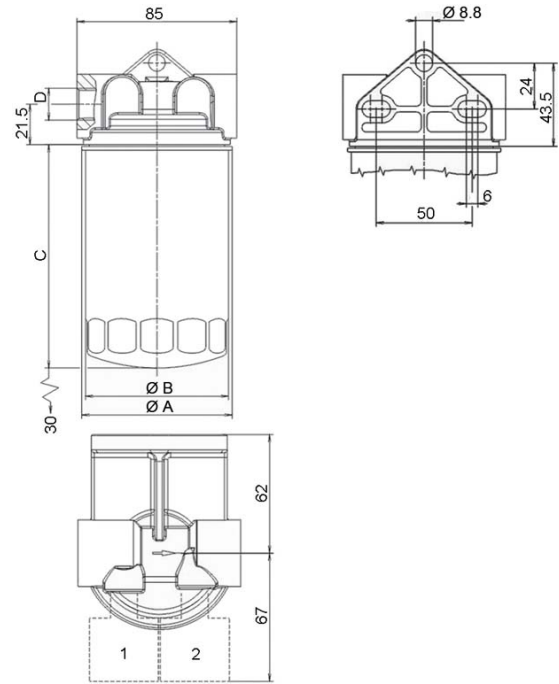

1 = pressure gauge

2 = vacuum gauge

Subject to technical alteration without prior notice.

9. Dimensions

All dimensions except "D" in mm.

| Type | Ø A | Ø B | C | D | Weight [kg] Execution Mic* | Weight [kg] Execution Sm-x* |
|------------------|-----|-----|-----|-------|----------------------------------|-----------------------------------|
| Pi 1941/10/G 1/4 | 80 | 76 | 120 | G 1/4 | 0.67 | 0.82 |
| Pi 1941/10/G 3/8 | 80 | 76 | 120 | G 3/8 | 0.67 | 0.82 |
| Pi 1941/10/G 1/2 | 95 | 93 | 141 | G 1/2 | 0.82 | 1.02 |
| Pi 1941/10/G 3/4 | 95 | 93 | 210 | G 3/4 | 1.02 | 1.02 |

*Design with gauge + 0.1 kg

10. Installation, operating and maintenance instructions

10.1 Filter installation

When installing the filter make sure that sufficient space is available to remove the spin-on cartridge.

Preferably the filter should be installed with the spin-on cartridge pointing downwards.

10.2 When should the spin-on cartridge be replaced?

1. Filter equipped with the vacuum gauge for suction-side installation: During cold start the vacuum gauge may for a short period indicate > 0.2 bar. With increasing operating temperature the indicator needle must drop clearly below the 0.2 bar mark. Should this not be the case, the spin-on cartridge must be replaced after the end of the shift.
2. Filters without maintenance indicator: The spin-on cartridge should be replaced after the trial run or flushing of the system. Afterwards follow instructions of the manufacturer.
3. Please always ensure that you have original MAHLE spare cartridges in stock.

10.3 Change of spin-on cartridge

1. Stop system and relieve filter from pressure.
2. Unscrew the spin-on cartridge with the aid of a belt spanner by turning same to the left.
3. Make sure that the order number on the new spin-on cartridge corresponds to the order number of the name-plate.
4. The seal of the spin-on cartridge should be lightly oiled.
5. Screw cartridge on in accordance with the printed-on instructions.

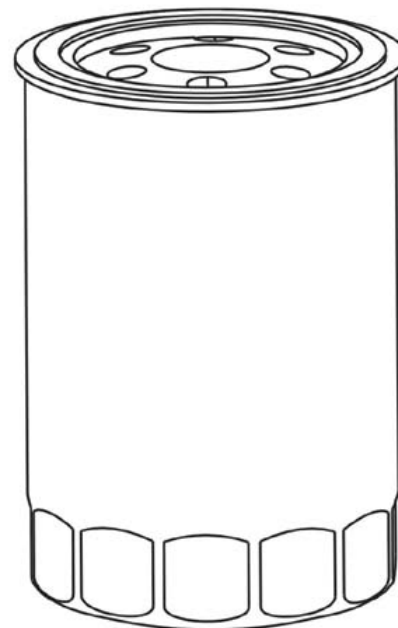
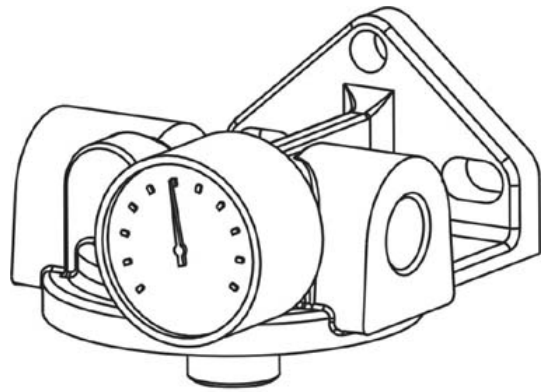

11. Spare parts list

| Position | Type | Order number |
|----------|----------------------------|--------------|
| ① | Pressure gauge (not shown) | 77870611 |
| ② | Vacuum gauge | 77617558 |

MAHLE Filtersysteme GmbH
Industriefiltration
Schleifbachweg 45
D-74613 Öhringen
Phone +49 (0) 7941/67-0
Fax +49 (0) 7941/67-23429
industrialfiltration@mahle.com
www.mahle-industrialfiltration.com
78357337.11/2010